

# CRUMA 670

**Perfect for small working spaces.** This ductless fume hood is recommended to remove from the working area gaseous polluting agents and/or solid particles/aerosols in a simple, efficient and cost effective way, protecting both the user and the environment.

**CRUMA 670** ductless fume hood uses the Cruma filtration system. Cruma ductless fume hoods designed to handle low toxic products are made of steel plate with antiacid polymerized epoxy coating and methylpropileno of high resistance.

**PROTECTION OF AND RESPECT FOR THE ENVIRONMENT** –The toxic chemical products are not released outside but retained within the filter.

**COST SAVINGS AND FAST SET UP** –No building work is needed to install ducts to channel the gas outside, which means fewer problems for a laboratory working at full capacity.

**FLEXIBLE** –It can be used in areas where it is difficult to remove/extract contaminated air, such as from the lower levels in buildings that have a number of floors.

**ENERGY SAVINGS** –The air that is sucked in is not expelled but recirculated back into the lab after the contaminating substances have been removed. This means that it is not necessary to increase the use of the air-conditioning or heating systems to compensate for the air removed.

**CERTIFIED** –Manufactured in Spain and certified by an external laboratory according to international standards and applying the criteria of ISO 9001.



## NEW FEATURES

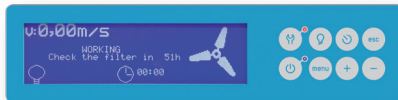

### More information on the new LCD display

- ✓ New size 127x34mm display
- ✓ Air speed continuously monitored
- ✓ Type of filter installed, working hours, expiration date and next revision date
- ✓ Open door warning through electronic photocell
- ✓ Countdown timer
- ✓ Clock and calendar

### New features and components

- ✓ Initial air flow cycle adequacy and final purge cycle
- ✓ Fault LED
- ✓ Control of air flow through Microprocessor
- ✓ Activated carbon filters with electronic chip
- ✓ LED illumination

### New alarms and scheduled warnings

- ✓ Open door warning
- ✓ Open door in off mode warning
- ✓ 60h of filter use warning
- ✓ Next validation warning
- ✓ Few hours of filter life warning
- ✓ Countdown timer warning
- ✓ Expired filter alarm (by hours)
- ✓ Expired filter alarm (by date)
- ✓ Temperature alarm
- ✓ Equipment without filter alarm
- ✓ Low barrier alarm

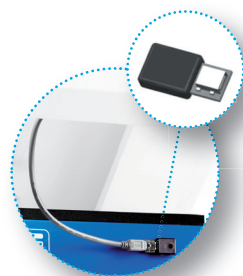

## USES

General chemistry involving small volumes of reagents or chemical compounds at ambient/moderate temperature in all types of laboratories:

- ✓ Research laboratories
  - ✓ Quality control laboratories
  - ✓ Clinical and hospital laboratories
  - ✓ University and school laboratories
- ...In general, in any kind of laboratory.

## TECHNICAL FEATURES

Number of filtration columns	1
Number of filters	1 to 2
Number of IP44 fans	1
Average volume of treated air	155 m <sup>3</sup> /h
Average face velocity	0,50 m/s
Internal volume of the cabinet	0,181 m <sup>3</sup>
Renewals inside the cabinet / min	14,3
Total electrical power consumption	91 W
Voltage-Frequency	110-220 V - 50-60 Hz
LED light intensity	18 W - 900 Lux
Noise level	48 dB
<b>Packaging:</b> 100% recycled wooden box with international phytosanitary certificate	Volume 0,28 m <sup>3</sup> Weight 58 Kg

## SIZES (MM)

External			Internal		
Width	Depth	Height	Width	Depth	Height
600	600	937	576	556	620

It is not a typographical error,  
**7 year warranty**

Because we are convinced of the quality of our products.



\*More information [www.cruma.es](http://www.cruma.es)

Well done, well shipped.  
**Our responsible packaging**

Wood box 100% recyclable with international phytosanitary certificate.



Do you need help or  
**technical assistance?**

Contact your distributor or call us if you have any questions or need technical support, spare parts, maintenance service...

**+34 93 370 61 62**

## SIZES (mm)

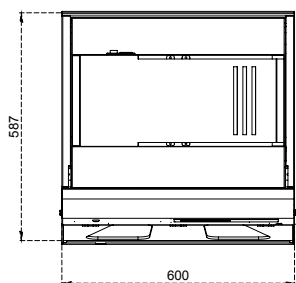
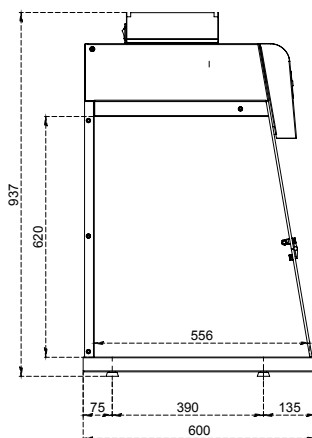
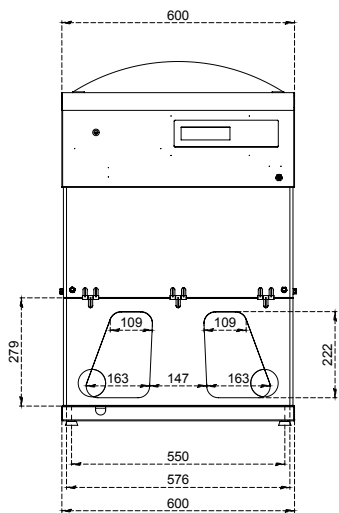

### SERIAL EQUIPMENT

Electronic circuit with large format LCD screen	Security levels: level 1 for users and level 2 for maintenance users
Electronic anemometer device	Electronic sensor monitoring continuously air face velocity
Photocell sensor device for open door detection	Electric device with open door alarm
Electronic control device for filters replacement	The filters incorporate a microchip with miniUSB connection that identifies the type of filter installed, the expiry date and the serial no.
Illumination	96 LED Tube high light intensity and low power consumption - 16 Watts / 700 Lux
Sampling system to analyze the filtered air at the exhaust	To detect the level of filter saturation
60 hours alarm	Countdown timer according to French NF X 15-211:2009
Electronic cronometre with audible alarm	To program the work inside the fume hood
Clock and calendar	Display of date and time
Working surface 1	Spill retention tray (2-10 liters) with working surface in white tempered glass
G4 Prefilter	G4 class pre-filtering blanket of synthetic biofibres (according to EN-779) for the retention of atmospheric dust
Cable entry holes (2)	Access to the rear wall for cables and / or services entry
Chemical Listing	Guide of retained products by type of filter
Warranty	7 years

### OPTIONAL EQUIPMENT

Movilair	Stand with wheels and internal tray in Epoxy coated steel
Tubular steel stand	Support stand in Epoxy coated steel
Working surface 2	Spill retention tray (2-10 liters) with working surface in phenolic resin
Working surface 3	Spill retention tray (2-10 liters) with working surface in inox steel
Transparent rear back panel	Transparent polymethylmethacrylate rear pannel 8 mm thick (light transmission of 93%). Ideal for teaching sessions
Voltage / Frequency	125 V / 50 Hz
Filter test kit	Dräger pump with reactive colorimetric tubes (pack 10u)

### MAIN STRUCTURE

Metal parts: base frame, rear wall and head	1.2 mm galvanized coated steel with anti acid polymer resin powder heat-hardened at 200 °C
Front and side panels	Transparent polymethylmethacrylate 6 mm thick (light transmission of 93%)

FILTER TYPES			
<b>Type A</b>	For <b>organic vapors</b> such as ketones, ethers, alcohols, xylenes ... Eventually it can be used for inorganic acids, but only if used in small quantities because this activated carbon is not impregnated and the excess of acid vapors could saturate it quickly.	<b>Type K</b>	For <b>NH3 vapors and amines</b> ; also good for other organic compounds. Carbon with metal salt complexes impregnation.
<b>Type BE</b>	For <b>inorganic acid vapors</b> as H2SO4, HCl, HNO3, and volatile sulfur compounds such as H2S, SO3, ... It can be used with organic vapors because the activated carbon incorporates impregnation of metal compounds and neutralizing salts. It is also suitable to filter organic and inorganic compounds when they are in similar proportions.	<b>Type ABEK</b>	<b>Mixed type</b> to be used when the ratios between organic, inorganic and NH3/amines are similar.
<b>Type F</b>	For <b>formaldehyde vapors</b> and derivatives; also good for other organic compounds. Carbon impregnated with Cu leads, so that it should never be used with inorganic acid vapors.	<b>Type D</b>	<b>HEPA H-14 filter</b> (High Efficiency Particulate Air, according to EN-1822: 1998) for filtering dust and smoke particles.

**MODULAR FILTRATION COLUMN FOR GASES AND PARTICLES** (according to NFX 15-211:2009)

**CLASE 2**

<b>Type G</b> Handling of liquid compounds/products		<b>Type GS</b> Handling of liquid and particles compounds/products	
--	--	---	--

**FILTRATION COLUMN FOR POWDERS**

<b>Type D</b> Handling of powder compounds	
---	--

Fan     
 Molecular Filter  
 HEPA-H14 Filter

**ACCORDING TO STANDARDS**

<b>Cabinets / Fume Hoods</b>	AFNOR NF X 15-211:2009 (France) BS 7258: 94 (UK) BS 7989: 2001 (UK) ANSI/ASHRAE 110-1995 (USA)
<b>Filters</b>	CSA Z 316.5-94 (Canada) EN-779: 1996 (HEPA & ULPA Filters) EN-1822:1998 (HEPA & ULPA Filters) EN-141:2001 (Gas Filters)
<b>Quality</b>	UNE EN ISO 9001:2008

Filters with microchip and USB connection, *intelligent filtering*

Information storage and interaction with the alarm system.



we recognise our responsibility and dependence towards a healthy environment and, therefore, donate 1% of our annual sales to environmental organisations around the world.

A. Canals

our **1%** engagement

**CRUMA**  
PLUG&PLAY RANGE



G-1



G-2



G-3



G-4



G-5

**CRUMA**  
CLASSIC RANGE



670



870

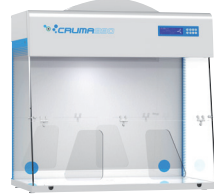

990



1010

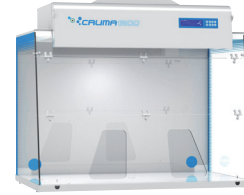

1200



ECO



**CRUMA**  
VENTED STORAGE  
CUPBOARDS

2010

**CRUMA**  
POWDER CABINETS



P-1



P-2

**CRUMA**  
PCR CABINET

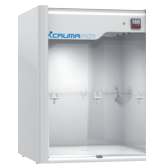

PCR

**CRUMA**  
CO<sub>2</sub> INCUBATOR



INCUBATOR

**CRUMA**  
LAMINAR FLOW CABINETS



670FL



870FL



FL1



FL2

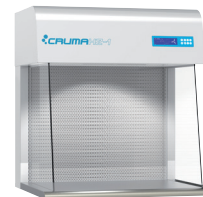

H2-1



H2-2

**CRUMA**  
BIOSAFETY CABINETS



BIO-1

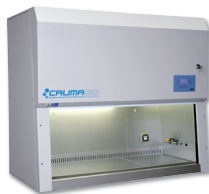

BIO-2

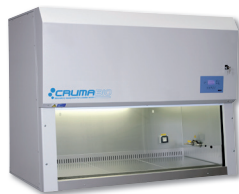

BIO-3



VIRUSFREE



CYTO-2&3

DISTRIBUTED BY: